

Specification Sheet

Part Number: 151-01660

One-piece ratchet closure allows for easy installation during pre- or final assembly.

Easy release feature simplifies quick adjustments and maintenance.

Impact modified, heat and UV stabilized PA66 provides long-term durability, indoors and out.

Zinc-plated steel mounting plate tolerates high torque and is treated to resist chemicals and salt spray.

Angled mounting plates are ideal for stacking RPCs or for avoiding obstructions or heat sources.

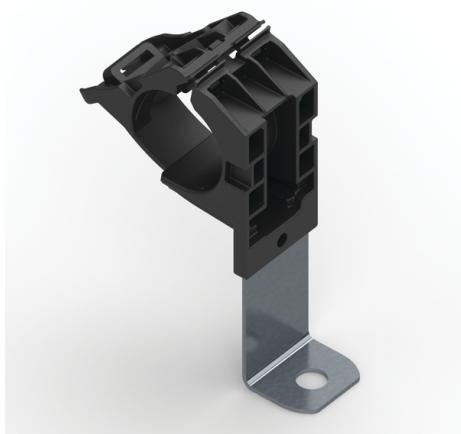

Ratchet P-Clamp, 0.76 - 1.42" Bundle Dia, 90° Long, 0.26" Hole Dia, PA66HIRHSUV/ST/ZN, Black, 140/ctn

Article Number	151-01660
Type	RCC90LM6
Color	Black (BK)
Quantity Per	box

Product Description	The Ratchet P-Clamp family offers versatility when managing wires, cables and hoses. The robust design and durable materials make it ideal for heavy duty applications, both indoors and out. The one-piece adjustable clamp can be closed by hand to the desired diameter. The release feature provides easy and nondestructive removal of cables simply by using a flat-head screwdriver. This nondestructive release allows the clamp to be reused without removing or replacing any bolts or screws.
Short Description	Ratchet P-Clamp, 0.76 - 1.42" Bundle Dia, 90° Long, 0.26" Hole Dia, PA66HIRHSUV/ST/ZN, Black, 140/ctn
Global Part Name	RCC90LM6-PA66HIRHSUV/ST/ZN-BK
Minimum Tensile Strength (Imperial)	100
Minimum Tensile Strength (Metric)	445
Length L (Imperial)	6.69
Length L (Metric)	169.8
Fixation Method	Screw Mounting
Variant	Long
Width W (Imperial)	1.37
Width W (Metric)	34.9
Bundle Diameter Min (Imperial)	0.76
Bundle Diameter Min (Metric)	19.4

Bundle Diameter Max (Imperial)	1.42
Bundle Diameter Max (Metric)	36.0
Cable Tie Width Max (Imperial)	0.52
Cable Tie Width Max (Metric)	13.2
Mounting Hole Diameter D (Imperial)	0.256
Mounting Hole Diameter D (Metric)	6.5 mm
Mounting Hole Diameter D Max (Metric)	6.5
Stud Diameter (Metric)	M6
Mounting Hole Centers (Imperial)	1.57
Material	Steel (ST) Zinc plated (ZN) Polyamide 6.6 high impact modified, heat and UV stabilized (PA66HIRHSUV)
Material Shortcut	PA66HIRHSUV ST ZN
Flammability	UL 94 HB
Halogen Free	Yes
UV Resistant (Yes/No)	Yes
Use Conditions	For Indoor and Outdoor Use

Plenum Rating	AH-2
Operating Temperature	-40°F to +221°F (-40°C to +105°C)
Reach Compliant (Article 33)	Yes
ROHS Compliant	Yes
UL Listed (US and Canada)	Yes
UL Listed (US)	Yes
Package Quantity (Imperial)	140
Package Quantity (Metric)	140
Customs Number	3926909988